

USER MANUAL

SIMPLICITY SERIES

MINIVATOR 1000

MINIVATOR 2000



Introduction

Thank you for choosing a Minivator stairlift from Handicare. Please read these operating instructions carefully. Your Minivator stairlift has been designed and built with careful attention to detail.

In order to obtain many years of trouble free use please follow the instructions, paying particular attention to the care and maintenance requirements. Handicare recommend that you do not undertake any maintenance tasks other than the routine care and cleaning explained in this handbook.

Please contact your Handicare dealer or our Customer Service Department in the United Kingdom on +44 (0) 8700 118282 if your stairlift requires attention and we would be pleased to help you.

European Standards

Handicare has been accredited as conforming to the international standard of manufacturing, recognised by the award of ISO 9001.

All Minivator stairlifts are built and tested to conform to the European Standards – EN 81-40:2008 as well as ISO 9386-2:2000. They also carry the CE mark.

Handicare are audited regularly to ensure we continue to conform to ISO 9001 and this provides you with the assurance of using a high quality and well manufactured product.

In accordance with EN81-40:2008 the emission sound pressure at the stairlift operators position is expected not to exceed 70dB(A).

**Issue No of this manual is 0311-1
ORIGINAL LANGUAGE ENGLISH**

Contents

Features of your Minivator stairlift	3
Operating your Minivator stairlift	4
Before use	4
On/off switch	4
Key switch	5
Operating toggle	5
Remote control	6
Diagnostic display	6
Emergency stop	7
Operating the swivel	7
Folding your stairlift	9
Slide Track	10
Hinged track (powered)	11
Hinged track (manual)	12
Emergency hand winding instructions	13
Trapped articles	13
Safety and servicing	14
Annual service	14
Warnings and precautions	14
Routine care and maintenance	15
Battery care and charging	15
Care and cleaning	15
Disposal of your stairlift	15
Appendix 1	16
Diagnostic display	
Appendix 2	20
Wiring diagrams	
Appendix 3	22
Declaration of Conformity	
Installation information	23

Features of your Minivator stairlift

- ❶ Folding seat base
- ❷ Swivel seat
- ❸ Remote control
- ❹ Folding footrest with safety edges
- ❺ Simple to operate key switch control
- ❻ Folding armrests
- ❼ Diagnostic display



Operating your Minivator stairlift



Figure 1

Before use

Before using your stairlift, MOST IMPORTANTLY please ensure the stairs are clear of other people, pets or any objects which may obstruct your stairlift. Then ensure that the arms, footplate and seat are folded down for use to ensure your safety (**Figure 1**).

- ⚠ For your safety the stairlift will not operate from the operating lever unless both arms are in the down position.
- ⚠ **BEFORE OPERATING YOUR STAIRLIFT ALWAYS FASTEN YOUR SAFETY BELT.**
- ⚠ Users with poor upper body positioning or control should have a body harness fitted.

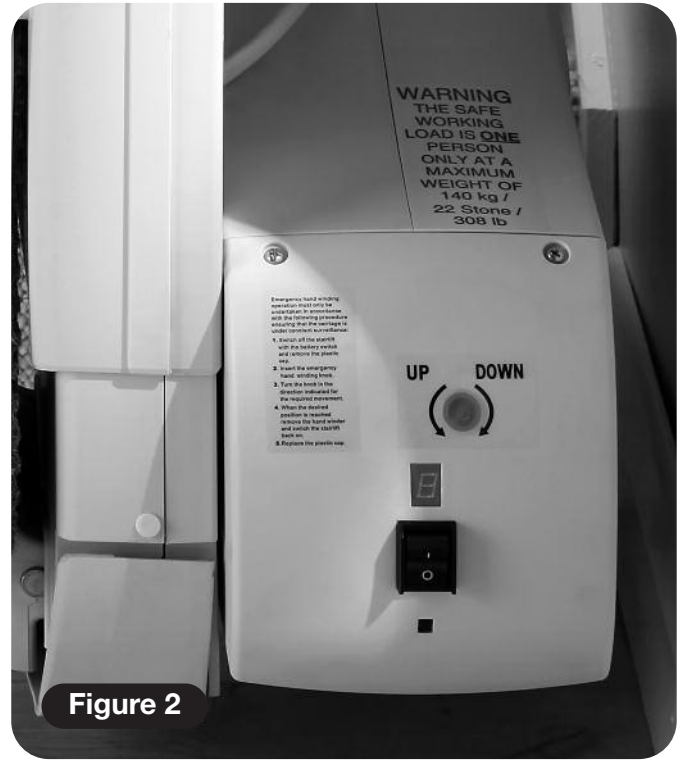

Figure 2

On/off switch

As well as a key switch your stairlift is fitted with an on/off switch (**Figure 2**). This switch is either located on the lower front panel of the lift or on the downside panel of the main body of the lift depending on your particular model.

- ⚠ Ensure that this is left in the 'ON' position. The fault diagnosis display panel will be illuminated to indicate this.

If you intend to be away from home for a long period, and decide to switch off the mains supply, it is important that you also switch off the lift from this on/off switch.

This will ensure that the lift batteries will remain charged while you are away.



Key switch

Your Minivator stairlift is fitted with a key switch (**Figure 3**). The stairlift cannot be operated unless the key is inserted and turned to the on position.

- ⚠ The key switch is provided to enable you to lock the stairlift to prevent it being used by others (for example children).

However, it can be left in the on position if desired.

- ⚠ If you remove your key for safety reasons, please ensure you put it in a safe place.
- ⚠ For safety reasons, we recommend that the key switch is turned off when the lift is not in use.

If the key switch is turned off the lift will continue to charge provided it is parked on a charge contact.

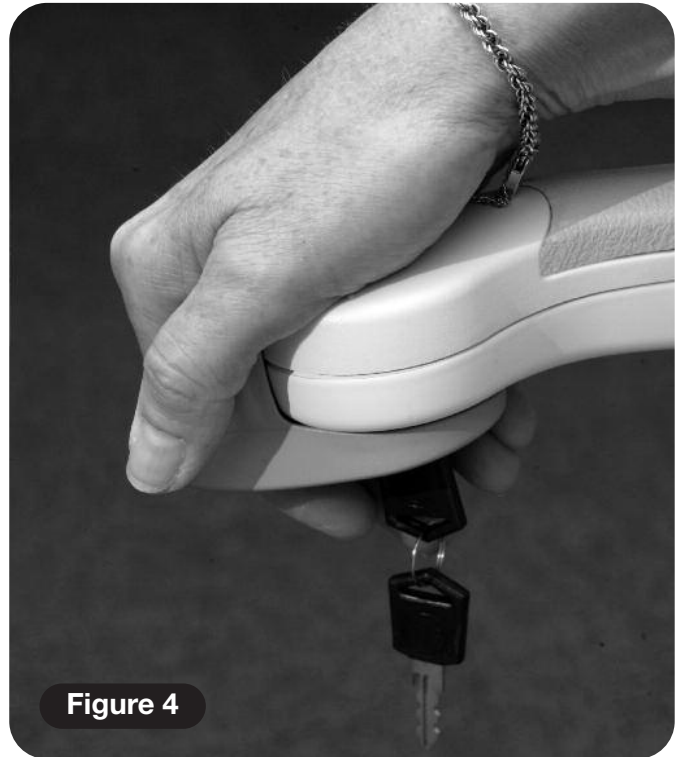

Operating toggle

Your Minivator stairlift is operated by simply pressing and holding the operating toggle in the direction you wish to travel (**Figure 4**). The stairlift will automatically stop when the toggle is released or the stairlift has reached the end of its travel.

PLEASE NOTE:

In the interest of safety, initial activation of the stairlift is delayed by 1 second from pressing and holding the operating toggle to avoid accidental operation. If the toggle is released while the lift is in motion, the lift will stop and a delay of 1 second will occur before the toggle will restart the lift.

When changing the direction of travel the delay will be 3 seconds before the lift begins to move.

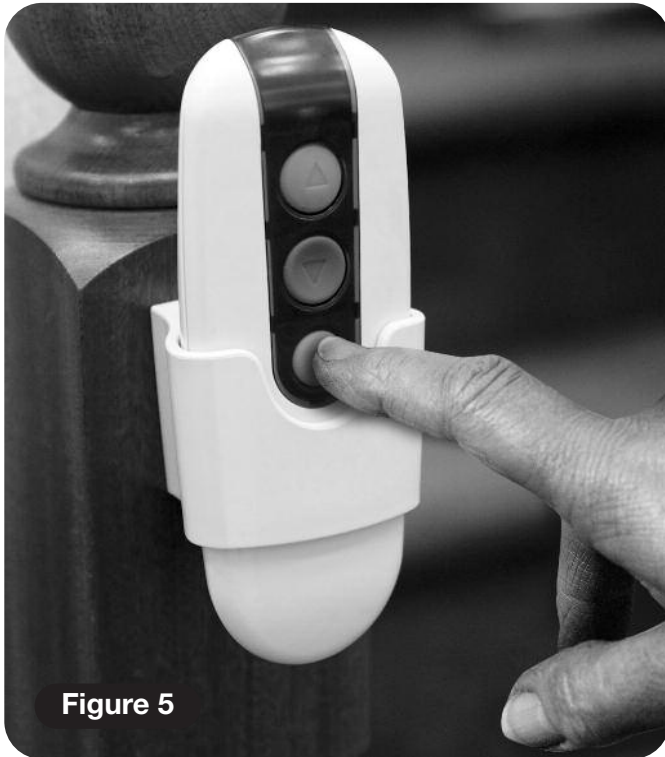

Remote control

The remote control (**Figure 5**) is used to call the lift to either the top/bottom of the stairs or to operate a powered folding hinge where fitted. The control may also be used by an attendant where the user is unable to operate the stairlift themselves.

The attendant should always remain off the staircase until the stairlift is stationary.



Diagnostic display

The stairlift is fitted with a diagnostic display (**Figure 6**) that displays a code to help diagnose faults. The display is either mounted on the lower front panel of the lift or on the downside panel of the main body of the lift depending on your particular model. Refer to **Appendix 1** for an explanation of the diagnostic codes. If you should experience a problem with your lift please examine the display and make a note of any codes that are displayed. Please inform the customer services operator of these codes when reporting any fault.

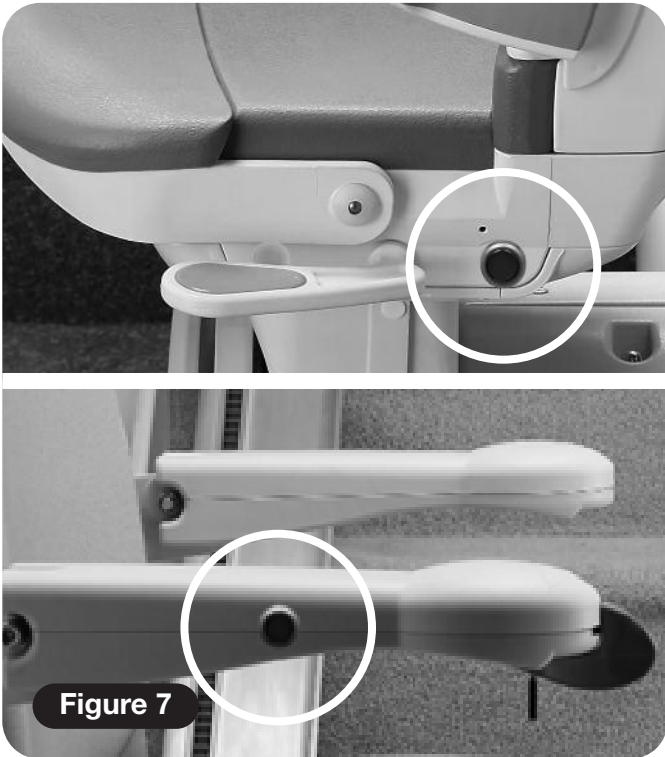

Emergency stop

In the event of an emergency the Stairlift and all its powered features can be stopped by pressing the emergency stop button.

The emergency stop button is the red button located on the upside of the seat base, or the control arm on a Simplicity or Simplicity+ (Figure 7). When activated the button will light up.

- ⚠ The emergency stop button will completely immobilise the lift. To restore normal operation press the button for a second time.



Operating the swivel

A swivel seat is provided to enable you to mount/dismount the seat more easily at the top of the stairs by swivelling you on to the landing.

To operate the seat swivel, wait until the stairlift has stopped.

To swivel the seat hold either (there is one both sides of the seat) swivel lever down or pull it up (only up on the Simplicity or Simplicity+ model). This will release the seat lock and allow you to move the seat round by pushing away from the footplate. When the seat reaches 90 degrees it will lock in position (Figure 8).

You should not attempt to leave the seat until it has firmly 'clicked' into its locked position.

To swivel in the opposite direction follow the same procedure, but push away from the landing.

Operating your Minivator stairlift

Power operated swivel (optional)

In order to swivel the seat hold the operating toggle in the up direction. When the stairlift reaches the top of the stairs continue to hold the operating toggle in the up direction. The stairlift will beep three times and then the seat will swivel. When the seat is fully swivelled to 90 degrees the seat will stop.

You should not attempt to leave the seat until it is fully rotated.

To swivel in the opposite direction follow the same procedure in reverse. Push the operating lever in the down direction. The seat will beep three times and then after a short pause it will rotate to the driving position. Continue to hold the operating lever in the down direction. The stairlift will then again beep three times before beginning its descent.

PLEASE NOTE:

In an emergency, should the power swivel fail to operate, a red emergency swivel lever is attached to the downside of the lift. The emergency lever should be twisted to break the anti-tamper seal and must be held in place to operate the swivel mechanism (**Figure 9**).

- ⚠ YOU SHOULD REPORT A FAILURE IN THE POWER SWIVEL MECHANISM IMMEDIATELY TO YOUR SERVICE PROVIDER.
- ⚠ SHOULD YOU REQUIRE A REPLACEMENT ANTI-TAMPER SEAL CONTACT YOUR DEALER OR HANDICARE.

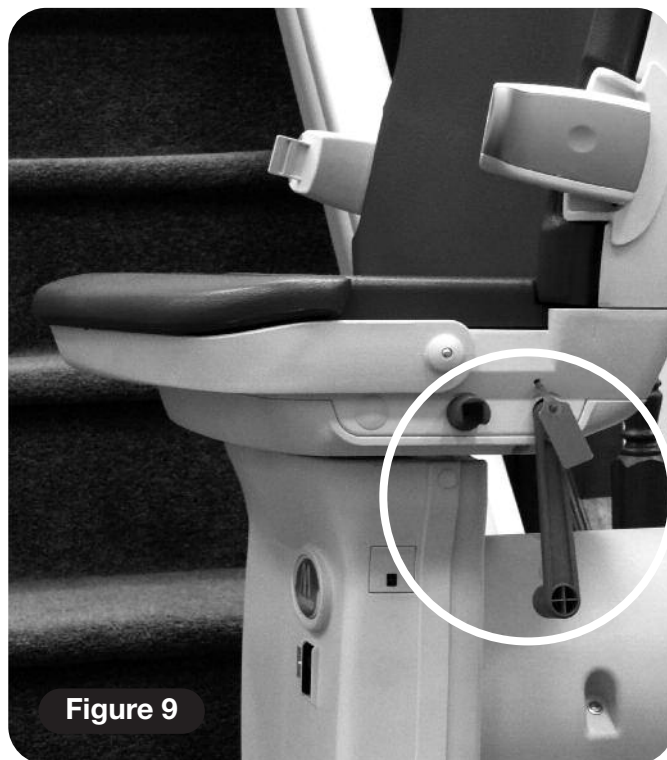

Figure 9

⚠ SAFETY PRECAUTIONS

NEVER

Swivel the seat without the safety belt fastened.

NEVER

Mount or dismount the swivel seat unless it is locked in position.

NEVER

Try to operate the swivel seat whilst the stairlift is in motion. (As a safety precaution, should you try to use it whilst the lift is in motion, it will cause the lift to stop).

NEVER

Attempt to travel up or down the staircase unless the seat is in the correct position (i.e. facing directly across the staircase).



Folding your stairlift

Your Minivator stairlift seat, armrests and footrest can be folded to allow easier passage up and down stairs when it is not in use (**Figure 10**).

▲ SAFETY PRECAUTION

ALWAYS RETURN THE STAIRLIFT TO ITS STOWED POSITION. I.E. WITH ARMRESTS, SEAT AND FOOTREST FOLDED AND THE CHAIR PARALLEL TO THE TRACK AS SHOWN IN **FIGURE 10**, SO THAT EXITS ARE NOT OBSTRUCTED.

Power footplate – seat squab operated (optional)

If your stairlift is fitted with a power footplate operated from the seat squab it will automatically fold away the footplate when the front seat squab is lifted. It will also lower the footplate when the front seat squab is lowered.

Power footplate – arm switch operated (optional)

If your stairlift is fitted with a power footplate operated from the arm it will have an additional switch under the arm (**Figure 11**). To lower the footplate, use the rocker switch under the arm. To lift the footplate move the rocker switch to its alternate position.

PLEASE NOTE:

If moving the footplate while seated on the stairlift please ensure your feet do not obstruct the footplate whilst it is in motion.

Minivator Slide Track or Hinged track

In some installations a hinged track or Minivator Slide Track may be necessary, usually to move the track out of the way of the doorway at the foot of the stairs.

The Minivator powered hinged track and Slide Track are fully automatic in operation and will function as follows:

Minivator Slide Track (optional)

Going up the stairs

Mount the stairlift as previously directed and push the operating toggle in the up direction. The stairlift will, after a short delay, move up the stairs. Both the stairlift and the Slide Track will move at the same time, though the stairlift will only travel at half speed whilst the track is also moving.

Once the Slide Track has reached the end of its travel (maximum 400mm) the stairlift will gradually increase to its normal running speed and continue to the top of the stairs – KEEP THE TOGGLE PRESSED IN THE UP DIRECTION.

Going down the stairs

Mount the stairlift as previously directed and push the operating toggle in the down direction. The stairlift will, after a short delay, move down the stairs. Both the stairlift and the Slide Track will move at the same time, though the stairlift will only travel at half speed whilst the track is also moving. Once the Slide Track has reached the end of its travel (maximum 400mm) the stairlift will gradually increase to its normal running speed and continue to the bottom of the stairs – KEEP THE TOGGLE PRESSED IN THE DOWN DIRECTION. ON SHORTER TRACKS THE STAIRLIFT MAY REACH THE END OF THE TRACK BEFORE THE SLIDE TRACK REACHES THE END OF ITS TRAVEL.



Figure 12

IN THIS SITUATION KEEP THE TOGGLE PRESSED IN THE DIRECTION OF TRAVEL UNTIL ALL MOTION HAS CEASED.

Parking the Stairlift

WHEN THE STAIRLIFT IS NOT IN USE IT SHOULD BE MOVED AWAY FROM THE BOTTOM OF THE STAIRS SO THAT IT DOES NOT CAUSE AN OBSTRUCTION.

To park the stairlift, press and hold the UP button on the handset. The lift will travel up the stairs and the Slide Track will move in the UP direction. Continue to hold the UP button until the Slide Track and stairlift are no longer causing an obstruction. If you release the UP button the lift or Slide Track will stop moving. To continue, press and hold the UP button again. After a short delay movement will start again.

⚠ WARNING

BEFORE YOU OPERATE THE SLIDE TRACK PLEASE REMOVE ANY OBSTACLES WHICH MAY OBSTRUCT THE TRACK.

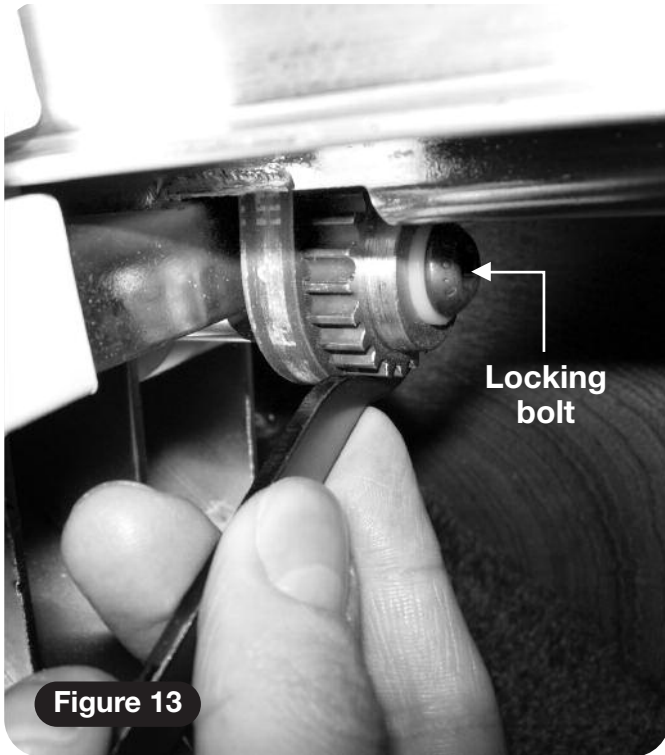

Emergency Manual Override

Your Slide Track is fitted with a manual override that allows the track to be moved in case of an emergency. This is positioned towards the bottom of the track (**Figure 12**).

To move the Slide Track manually you must first loosen the locking bolt (**Figure 13**). Use the spanner supplied (**Figure 14**) as shown in (**Figure 13**) to move the Slide Track.



Hinged track powered (optional)

Going up the stairs

Mount the stairlift as previously directed and push the operating toggle in the up direction. The stairlift will, after a short delay, move up the stairs. Once the lift has passed the hinged track section it will stop – KEEP THE TOGGLE PRESSED IN THE UP DIRECTION. At this time the seat will beep three times whilst the hinge track automatically folds itself away. When the hinge is fully folded the stairlift will continue to the top of the stairs.

Going down the stairs

Mount the stairlift as previously directed and push the operating toggle in the down direction. The stairlift will, after a short delay, move down the stairs. Before the lift has reached the hinged track section it will stop – KEEP THE TOGGLE PRESSED IN THE DOWN DIRECTION.



Figure 15

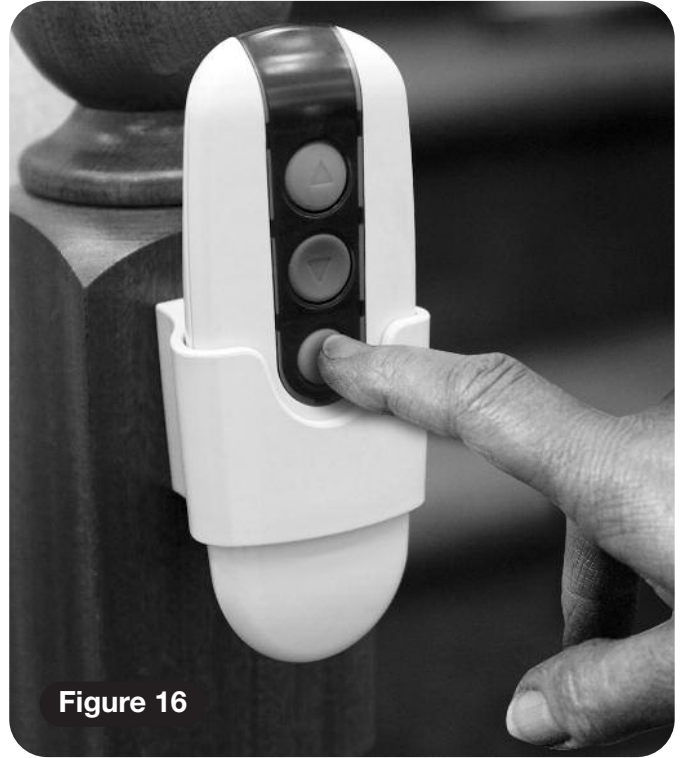

Figure 16

At this time the seat will beep three times whilst the hinge track automatically folds open (**Figure 15**). When the hinge is fully open the stairlift will continue to the bottom of the stairs.

Parking the Stairlift

WHEN THE STAIRLIFT IS NOT IN USE IT SHOULD BE MOVED TO ITS PARK POSITION SO THAT IT DOES NOT CAUSE AN OBSTRUCTION.

THE STAIRLIFT DOES NOT CHARGE WHEN IT IS PARKED AT THE BOTTOM OF THE STAIRS.

To park the stairlift, press and hold the P button on the handset (**Figure 16**). The lift will travel up the stairs to its park position and the hinge will automatically fold itself. If you release the P button the lift or track will stop moving. To continue, press and hold the P button again. After a short delay movement will start again.

⚠ WARNING

BEFORE YOU OPERATE THE HINGED TRACK PLEASE REMOVE ANY OBSTACLES WHICH MAY OBSTRUCT THE TRACK.

Hinged track manual (optional)

Before raising the manual hinged track park the stairlift on the charge points, above the hinge, or at the top of the stairs.

Your stairlift will not work unless the track has been lowered.

When your stairlift is not in use it should always be positioned away from the hinged section at a charging point with the hinge in the raised position.

⚠ WARNING

BEFORE YOU OPERATE THE HINGED TRACK PLEASE REMOVE ANY OBSTACLES WHICH MAY OBSTRUCT THE TRACK.

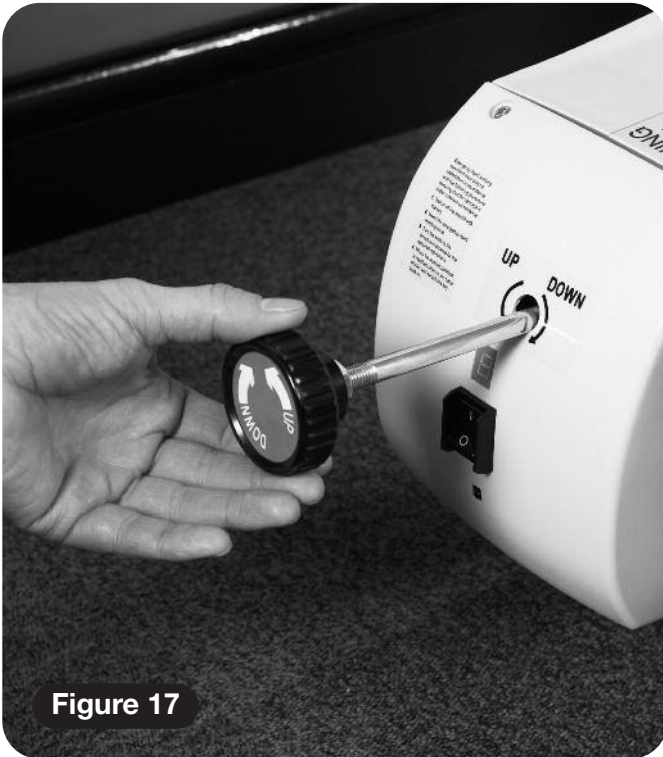

Emergency hand winding instructions

In the unlikely event that the lift has a total power failure or runs on to the final track stops there is an emergency hand winding procedure. Please follow these steps:

- 1 Switch off the stairlift with the key.
- 2 Insert the emergency hand winding knob (**Figure 17**). The position of the hand winding hole will always be on the downside main body panel, regardless of the model that you have.
- 3 Turn the knob in the direction indicated for the required movement.
- 4 When the desired position is reached remove the hand winder and switch the lift on.

If in any doubt contact your local Handicare approved dealer or ring Handicare direct on +44 (0) 8700 118282.

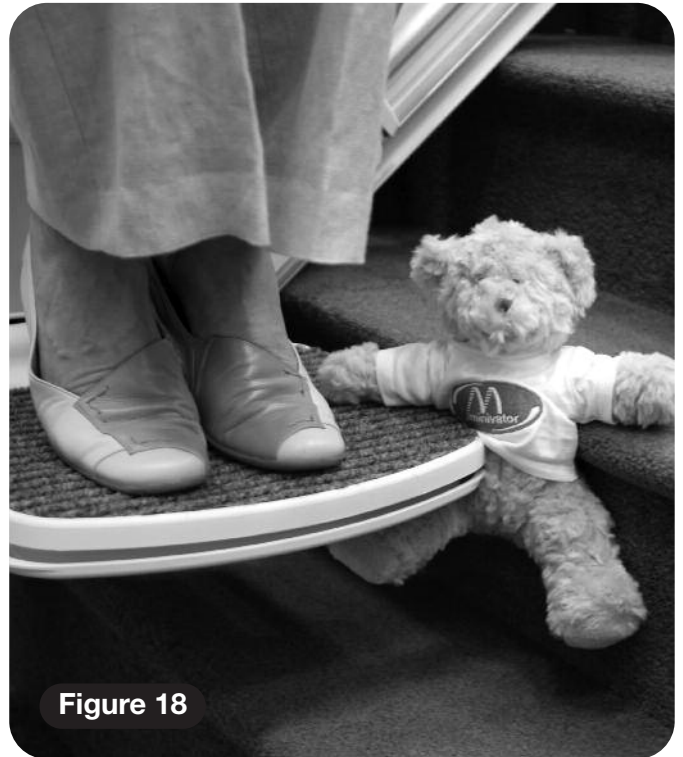

Trapped articles

Your stairlift is fitted with safety edges on the bottom of the footrest and on the lift itself that will stop the stairlift should any article become trapped by the footrest (**Figure 18**).

To remove the article reverse the stairlift away from the object then have the object removed from the staircase. Proceed on your stairlift as normal.

Annual service

We advise that your stairlift is serviced after the first 12 months and thereafter AT LEAST EVERY 12 MONTHS. The service history log must be filled in regularly as a proof of specified maintenance. Failure to do so may invalidate the product warranty.

This work must be carried out by a competent person, i.e. a Handicare approved dealer.

If in doubt, please contact the Handicare Service Department on +44 (0) 8700 118282.

If you own your stairlift and no longer require it your dealer or Handicare may be interested in purchasing it.

Warnings and precautions

NEVER

Allow more than one person to use the stairlift at any one time.

The maximum carrying capacity is dependant on the model that you have:

Simplicity 950 series	140kg (22 Stone/310lb)
Simplicity 950 series with Slide Track/hinge	120kg (19 Stone/265lb)
1000 series standard or with hinge/platform	137kg (21 ½ Stone/300lb)
1000 series heavy duty 1000 series US standard	160kg (25 Stone/350lb)
2000 series	115kg (18 Stone/252lb)
2000 series heavy duty	137kg (21 ½ Stone/300lb)

NEVER

Allow children to play on or with the stairlift.

NEVER

Allow water to come into contact with the components in the stairlift. If you have to transport liquids DO SO WITH CARE.

NEVER

Use the stairlift without using the safety belt, or any other harnesses fitted.

NEVER

Use the stairlift in a standing position.

NEVER

Place objects in the track or leave objects on the stairs, where they could come into contact with the lift in operation. Your stairlift is fitted with pressure sensitive side edges and undertray on the footplate, which will automatically stop the lift if it detects any obstructions.

ALWAYS

Keep your FEET ON THE FOOTPLATE whilst the stairlift is in motion, and try to avoid your feet hanging over the edges of the footplate.

NEVER

Swivel the seat until the lift has come to a stop at the top or bottom of the staircase.

ALWAYS

Fold the chair when it is not in use to avoid obstructing exits.

WARNING

If the overspeed governor is activated it should only be reset by a competent person, i.e. a Handicare approved dealer. Activation of the overspeed governor is indicated by the lift not being able to be driven down the stairs and the diagnostic display showing 0.

NEVER

Use for firefighting or evacuation during a fire.

NEVER

Use the track as a handrail.

Battery care and charging

Your Minivator stairlift is battery powered and will continue to work for a period of time even if you have a power cut. You should normally be able to travel up and down the stairs at least 10 times without needing to charge the batteries. Particularly in the event of a power cut, however you should always ensure that there is sufficient light to allow safe travel, and especially at each end of the track where you get on and off the lift.

Your stairlift track is fitted with charging points, normally at the top and bottom of the staircase. Your stairlift should be left on one of these charging points when not in use to ensure that the batteries are charged. If the stairlift makes a beeping noise and/or the display show a “2” when it is left on a charging point and it is not in use IT IS NOT CHARGING. Please check that the power supply for the stairlift is switched on. If it is switched on and the beeping continues please contact your dealer or the Handicare Service Department on +44 (0) 8700 118282.

⚠ WARNING

If you are leaving the stairlift unattended for a long period of time and the power supply is turned off you **MUST** turn the main on/off switch on the stairlift to the off position to prevent damage to your batteries **(see page 4)**. Failure to do so could cause permanent damage to the batteries and require them to be replaced.

Maintenance

There are no user serviceable parts fitted to your stairlift. If any damage is visible or your stairlift sounds or behaves unusually contact Handicare or your approved dealer immediately. We advise that your stairlift is serviced after the first 12 months and thereafter **AT LEAST EVERY 12 MONTHS**.

Care and cleaning

Before cleaning any part of your Minivator stairlift, please ensure you have removed the key.

Your Minivator stairlift is manufactured from a variety of materials, all with easy “wipe clean” surfaces. The seat and body covers can be wiped over with a damp, **NOT WET**, cloth and a small quantity of washing up liquid.

PLEASE DO NOT use abrasive cleaners, bleach or solvent based cleaners, as these will damage the seat.

To clean the track, first send the stairlift to the top of the stairs. The track can be cleaned with a damp cloth. When most of the track is clean, move the stairlift to the bottom of the stairs and finish cleaning the track making sure that none of the cleaning debris falls on to it.

To maintain your Minivator stairlift in good mechanical order, it is recommended that annual services are carried out by qualified service engineers.

Disposal of your stairlift

Your stairlift has been manufactured using high quality materials and components, which can be recycled and reused.

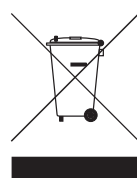

The crossedout wheeled bin symbol indicates that your stairlift is covered by the European Directive 2002/96/EC, which governs the disposal of waste electrical and electronic equipment.

This means that your stairlift should not be disposed of as household waste but should be appropriately disposed of for recycling.

Recycling this product will help to protect the environment by ensuring that all materials contained in the stairlift are appropriately handled.

Please contact Handicare on +44 (0) 8700 118282, your dealer or your local civic office for further disposal information.

Diagnostic Display

 **Code:** None **Description:** No display.

Self help action:

Press the toggle switch and see if display comes on. Check that the main power switch on the lift is turned on. If this does not clear the fault, contact your dealer or Handicare.

 **Code:** Okay **Meaning:** Charging.

Self help action:

If lift does not drive check that the arms are down. If this does not clear the fault, contact your dealer or Handicare.

 **Code:** 0 **Meaning:** Final limit activated or cable short circuit.

Self help action:

Check that the keyswitch is on and seat is fully swivelled to the drive position. If this does not clear the fault, contact your dealer or Handicare.

 **Code:** 1 **Meaning:** Requires charge.

Self help action:

The stairlift batteries require charging. Drive the lift to the charge contacts – if the 'Okay' code does not show contact your dealer or Handicare.

 **Code:** 2 **Meaning:** Off charge.

Self help action:

The stairlift is not parked on a charging position or is not charging. Drive the lift to the charge contacts – if the 'Okay' code does not show or the lift is already on the charge contacts check the power supply is on. Failing this contact your dealer or Handicare.

 **Code:** 3 **Meaning:** Ends limit activated.

Self help action:

Contact your dealer or Handicare.

 **Code:** 4 **Meaning:** Safety edge (up/down direction) activated – footplate.

Self help action:

Contact your dealer or Handicare.

5

Code:
5

Meaning:
Ends limit activated.

Self help action:

Contact your dealer or Handicare.

6

Code:
6

Meaning:
Safety edge
(up/down direction)
activated – footplate.

Self help action:

Contact your dealer or Handicare.

7

Code:
7

Meaning:
Batteries approaching
critical level.

Self help action:

The stairlift batteries require charging.
Drive the lift to the charge contacts – if the
'Okay' code does not show contact your
dealer or Handicare.

8

Code:
8

Meaning:
Shows when toggle
switch is activated
in up/down direction.

Self help action:

N/A.

9

Code:
9

Meaning:
Shows when toggle
switch is activated
in down/up direction.

Self help action:

N/A.

A

Code:
A

Meaning:
Hinge is open.

Self help action:

N/A.

b

Code:
b

Meaning:
A switch is active at
power on i.e. Toggle Up,
Toggle Down, IR Up,
IR Down or Learn.

Self help action:

Contact your dealer or Handicare.

C

Code:
C

Meaning:
The IR address
(dip switch) does
not match.

Self help action:

Contact your dealer or Handicare.

Appendix 1



Code:

d

Meaning:

The main power relay is welded closed.

Self help action:

Contact your dealer or Handicare.



Code:

E

Meaning:

The main power relay did not close.

Self help action:

Contact your dealer or Handicare.



Code:

F

Meaning:

Brake semi-conductor failed.

Self help action:

Contact your dealer or Handicare.



Code:

g

Meaning:

Brake not connected.

Self help action:

Contact your dealer or Handicare.



Code:

H

Meaning:

The main power relay has closed early.

Self help action:

Contact your dealer or Handicare.



Code:

J

Meaning:

Hinge interlock switch error.

Self help action:

Push the up direction on the toggle or remote until the lift stops at the top of the stairs. If this does not clear the fault contact your dealer or Handicare.



Code:

L

Meaning:

Current limit exceeded.

Self help action:

Contact your dealer or Handicare.



Code:

n

Meaning:

Half speed.

Self help action:

If permanently showing contact your dealer or Handicare.



Code:
o

Meaning:

The main control board has a memory problem.

Self help action:

Contact your dealer or Handicare.



Code:
P

Meaning:

Powered swivel did not respond.

Self help action:

Contact your dealer or Handicare.



Code:
r

Meaning:

No charge current.

Self help action:

Make sure that power supply is switched on from mains. If it is contact your dealer or Handicare.



Code:
U

Meaning:

Faulty power supply.

Self help action:

Contact your dealer or Handicare.



Code:
y

Meaning:

The main control board has a software fault.

Self help action:

Contact your dealer or Handicare.



Code:
N/A

Meaning:

Over current.

Self help action:

Contact your dealer or Handicare.



Code:
N/A

Meaning:

Lift is in “sleep mode” to conserve battery power.

Self help action:

Press toggle or handset button to wake lift.

Note: If the display is showing anything but the diagnostic codes listed it requires resetting.

Drive the lift off the charge contacts. Turn the main switch on the unit off for 10 seconds and then back on.

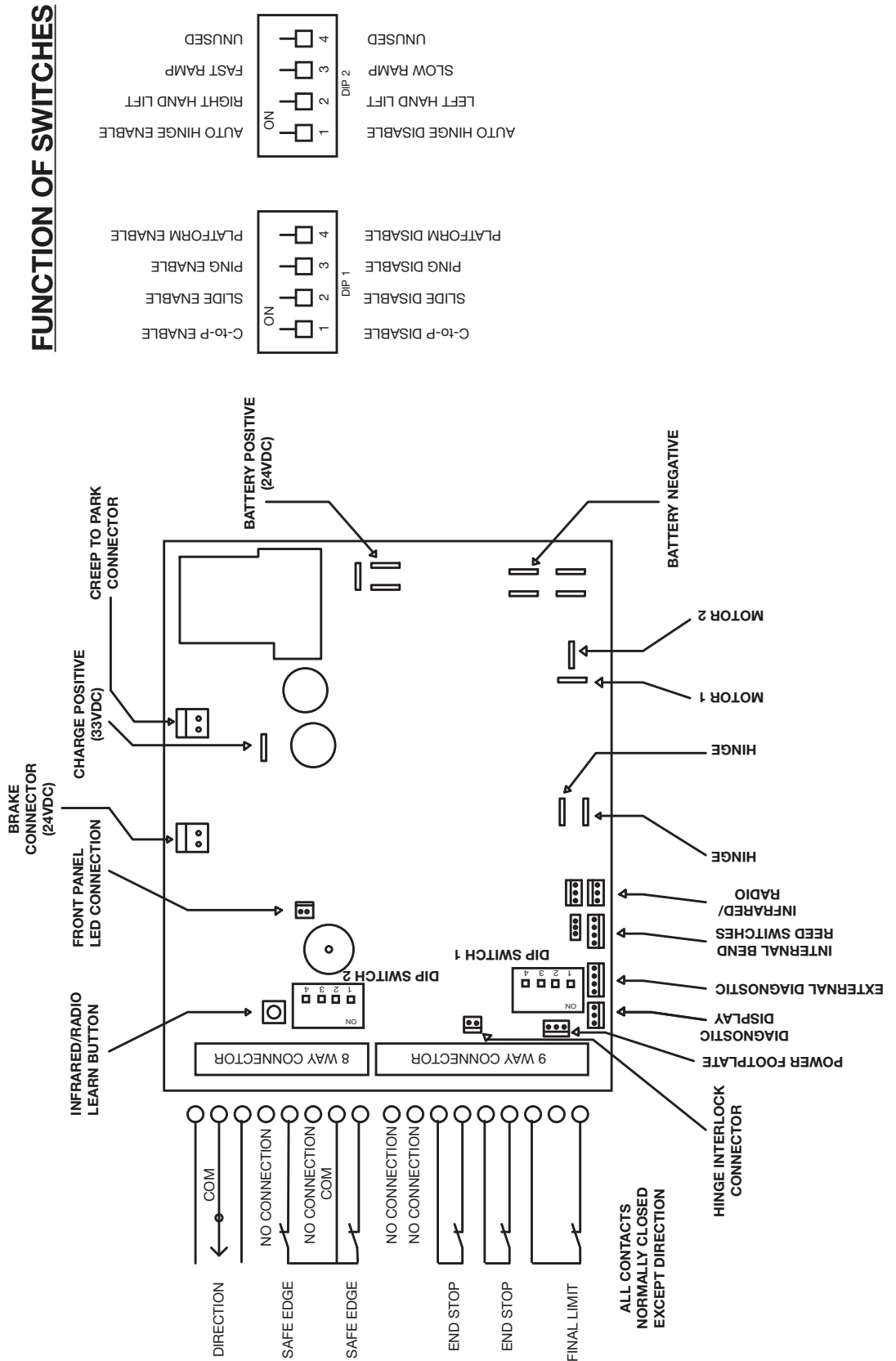

MS 126 Power Swivel PCB

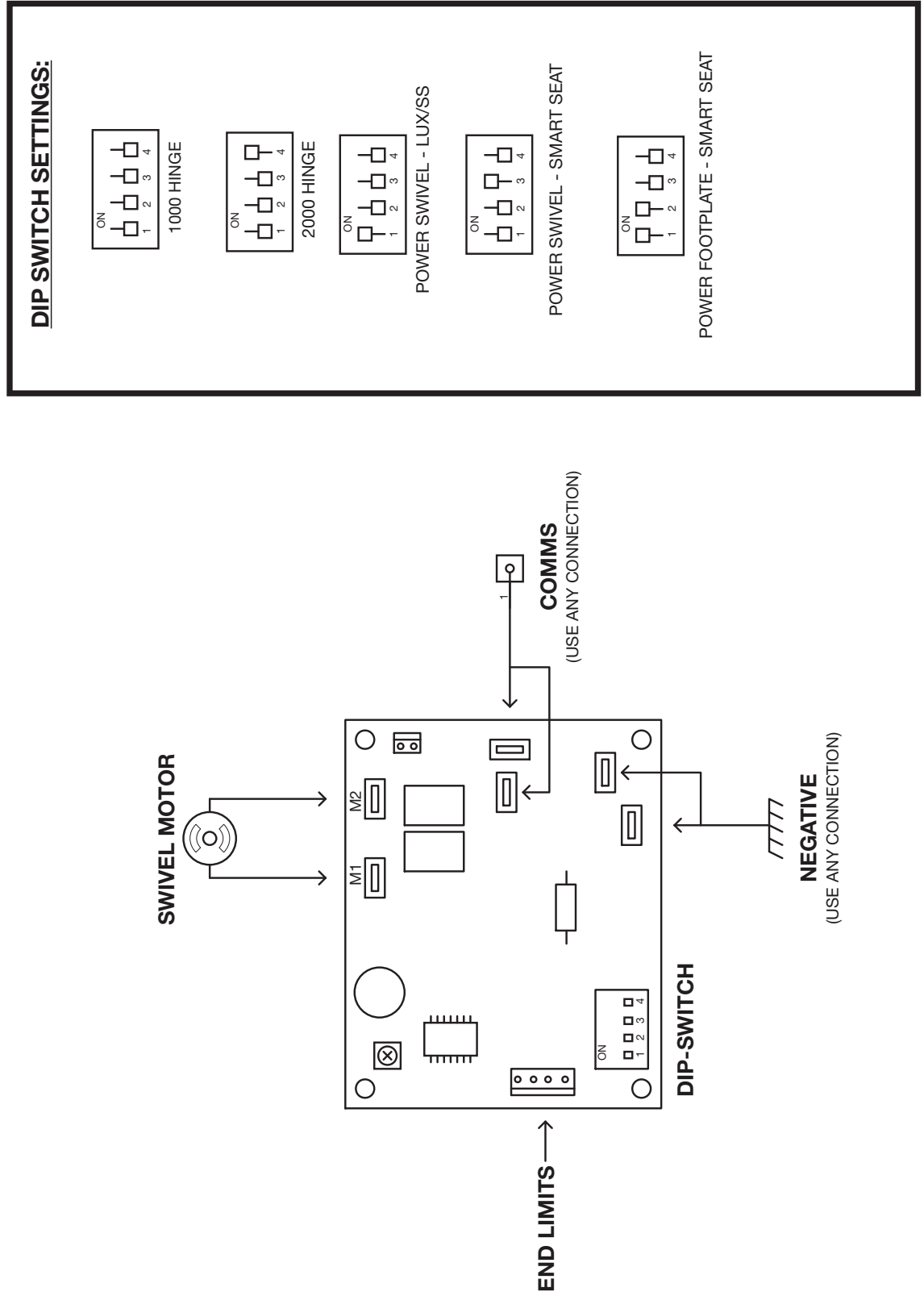

We

Handicare

of

82 First Avenue, Pensnett Estate, Kingswinford
West Midlands DY6 7FJ, England.

Declare under our sole responsibility that the products

Minivator Simplicity 950 Series Stairlifts Minivator 1000 Stairlift Minivator 2000 Stairlift

have been manufactured in conformity with the
following standards and specifications:

**EN 81-40:2008
ISO 9386-2:2000**

and that the products to which this declaration relates
are in conformity with the following EU directives:

**Electro Magnetic Compatibility Directive 2004/108/EC
Low Voltage Directive – 2006/95/EC
Machinery Directive – 2006/42/EC**

Signed: G.M. Welch

Name: G.M. Welch

Date: 20th April 2011

Position: New Product Development Manager

Technical documentation is available on request
from Handicare at the address above.



Important information about your stairlift which should be completed by the installation engineer.

Installed by: (Company Name)

Serial No:

Date of installation:

First service due:

Dealer Stamp:



Handicare, 82 First Avenue, Pensnett Estate
Kingswinford, West Midlands DY6 7FJ, England
Customer Services: +44 (0) 8700 118282
Textphone: (180015) 020 7490 8913 ext 05
Voicephone: (18002) 020 7490 8913 ext 05
Email: sales@handicare.co.uk

www.handicare.co.uk

Handicare Treppenlifte GmbH, Gesellenweg 7
32427 Minden, Deutschland
Tel: +49 (0) 571 97 33 980
Fax: +49 (0) 571 97 33 9833
Email: treppenlifte@handicare.de

www.handicare.de

North America

2201 Hangar Place, Suite 200
Allentown, PA 18109, United States
Tel: 610-266-5260
Toll Free: 866 276 LIFT/5438
Fax: 610-266-5266
Email: info@handicareusa.com

www.handicareusa.com

International websites

www.handicare.com

